

Revisions			
Rev	Description	Date	Appr.

DIMENSIONS ARE CENTERLINE OF .625" ENDMILL
 RELATIVE TO AXLE CENTERLINE AND INSIDE FACE OF DROPOUT

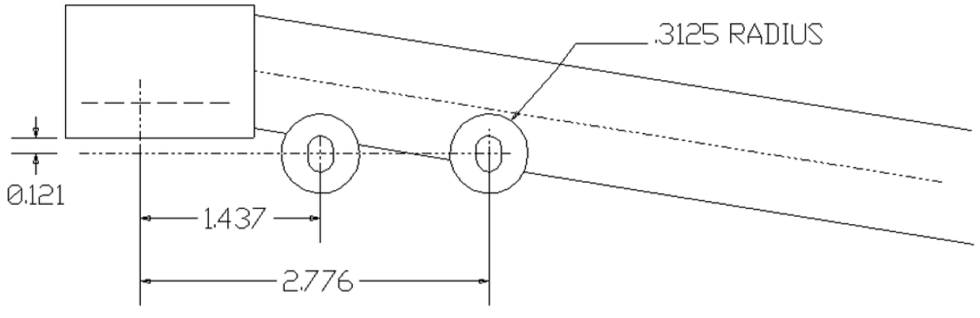

TOP OF MOUNT MUST BE 16 MM ABOVE AXLE CENTERLINE

MITER DETAIL, BK0030 AND BK2030		
Drawn by: MCN	Date: 11/15	Title:
Chkd by:	Date:	
Scale: 1 : 1	Tolerance: N/A	Drawing Number: BK0030M.DXF